



Quality Built to Protect
Both Research and Researchers



Class Biologically Clean, Ltd

810 Stewart Street
Madison, WI 53713

phone: 608.273.9661

fax: 608.273.9668

www.cbcclean.com

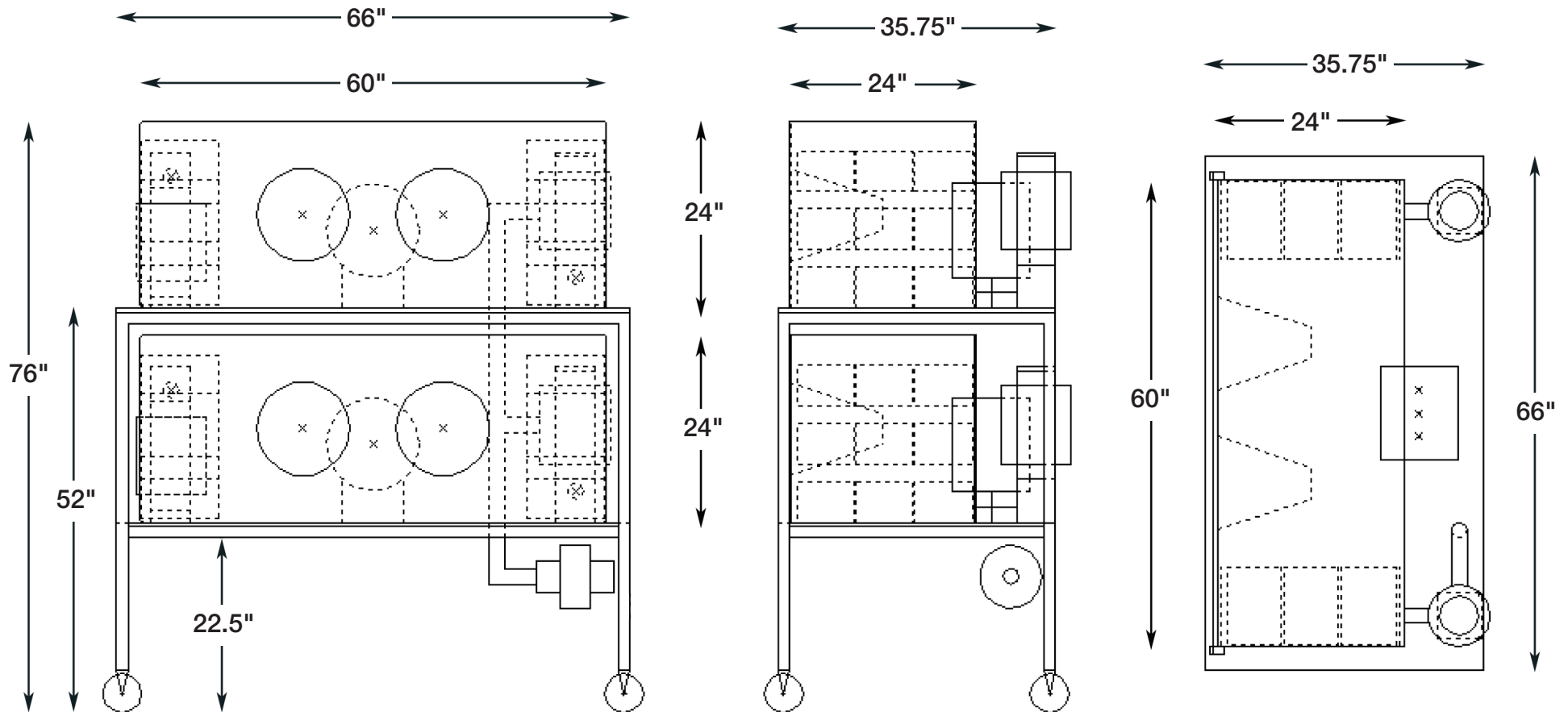

FRONT

SIDE

TOP

Standard Positive 5' x 2' x 2' Double Tiered Isolator System

Model # 50602424122